

# OPERATION AND MAINTENANCE INSTRUCTION MANUAL

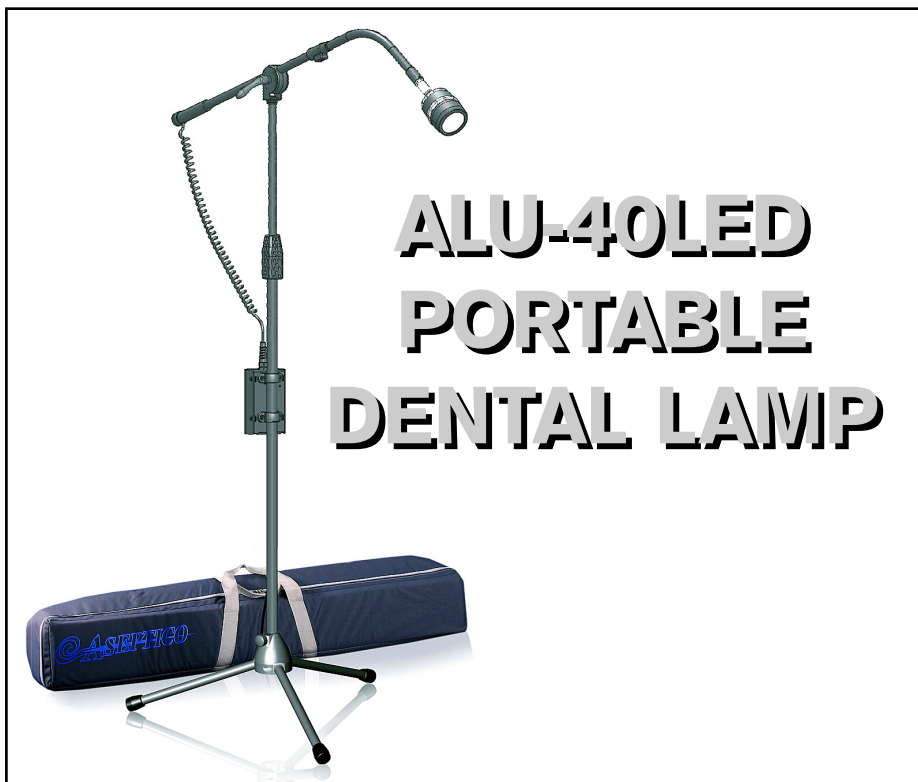

**Aseptic®**

# TABLE OF CONTENTS:

- Introduction .....1
- Package Contents .....1
- Safety Precautions .....2
- Setup .....3-4
- Operation .....5
- Maintenance .....6-7
- Parts Lists & Diagrams:
  - Figure-9 Lamp Stand Boom .....8
  - Figure-10 Lamp Stand & Pwr Supply .10
  - Figure-11 Lamp Head .....12
- Troubleshooting .....14
- Specifications .....15
- Symbol Definitions .....16
- Warranty .....17



P.O. Box 1548 • Woodinville, WA 98072  
 8333 216<sup>th</sup> Street S.E. Woodinville, WA 98072  
 International (425) 487-3157 • Toll Free (800) 426-5913  
[www.aseptico.com](http://www.aseptico.com) • [info@aseptico.com](mailto:info@aseptico.com)

Manufacturer



Aseptico Inc  
 8333 216 St SE  
 Woodinville  
 WA 98072  
 USA



EC	REP
----	-----

Advena Ltd  
 Pure Offices  
 Plato Close  
 Warwick  
 CV34 6WE  
 UK



CONFORMS TO UL STD 60601-1;  
 CERTIFIED TO CSA STD C22.2 NO. 601.1

**Intertek**  
3176038

INFORMATION CONCERNING THE ACCURACY AND PRECISION OF THIS PRODUCT MAY BE OBTAINED UPON REQUEST BY CONTACTING ASEPTICO AT THE ADDRESS SHOWN ON THIS PAGE.

To prevent injury to people and damage to property, please heed relevant warnings and remarks. They are marked as follows:

**WARNING:** Serious injury or death may result if ignored.

**CAUTION:** Damage to property or the environment may result if ignored.

**NOTE:** Important additional information and hints.

Your new Aseptico ALU-40LED Lamp is one of the finest operating lights available to the dental and medical professions. The ALU-40LED uses an LED light source which provides brilliant white light, reduced power consumption, and longer operating life. The universal voltage input Lamp operates from 100VAC to 240VAC, 50 and 60Hz, and it provides an auxiliary DC input that allows 12V and 24V battery operation in the field. The ALU-40LED features a compact lamp head with adjustable intensity and spotlight aperture controls, flexible gooseneck, telescoping tripod stand and padded carrying case.

## *Congratulations!*

This System is engineered to provide many years of reliable service. Please read the instructions provided in this manual to receive the best and longest service from your Aseptico equipment.

Separate manuals may be provided to cover the operation and maintenance of other accessories for your unit.

---

### **PACKAGE CONTENTS:**

- Portable Dental Lamp Assembly, PN: 120369
- Color Filter, PN: 461974 (For use with light-activated composites.)
- Two 0.160A Spare Fuses, PN: 830046
- One Each 110V Power Cord, PN: 840107, and 220V Adapter, PN: 840115
- Soft Padded Carrying Case, PN: 410084
- Operation and Maintenance Manual, PN: 420841
- Setup Guide, PN: 420884

### **PURCHASED SEPARATELY:**

- DC Battery-Power Clip Assembly (Optional), PN: AA-40DC-BC
- 12Vdc Automobile Power Adapter Assembly (Optional), PN: AA-40DC-LP
- Color Filter 5-Pack (Optional), PN: AA-40FK
- Lens Replacement Kit (Optional), PN: AA-40LK, Includes:
  - Fresnel Lens, PN: 461935
  - Color Filter, PN: 461974
  - Lens Cover, PN: 461936
  - Torx Key, PN: 490140 (For removing Fresnel Lens)
  - Three (3) Torx Screws, PN: 510727 (For mounting Fresnel Lens)

To prevent injury to people and damage to property, please heed relevant warnings and remarks. They are marked as follows:

**WARNING:** Serious injury or death may result if ignored.

**CAUTION:** Damage to property or the environment may result if ignored.

**NOTE:** Important additional information and hints.



## **SAFETY PRECAUTIONS:**

Aseptico accepts no liability for direct or consequential injury or damage resulting from improper use, arising in particular through the non-observance of the operating instructions, or improper preparation and maintenance of this product.

**CAUTION:** Use for intended purposes only. Failure to observe the operating instructions may result in the patient or user suffering serious injury or the product being damaged, possibly beyond repair. Before using this product, make sure that you have studied and understood the operating instructions.

**CAUTION:** Use of other Lamp filters or accessories from third-party manufacturers is the sole responsibility of the user.

**CAUTION:** All repairs to the LED Assembly, Boom Arm, and Power Supply are to be performed by authorized Aseptico service personnel only.

**WARNING:** Do not install where there is a risk of an explosion. The ALU-40LED is not intended for operation in the presence of flammable anesthetics or gases.

**CAUTION:** Connect AC power supply mains cable to a properly grounded outlet only.

**CAUTION:** The ALU-40LED Lamp is sensitive to shock and may be damaged if dropped or impacted against a hard surface.

**WARNING:** Do not disassemble or alter the Lamp's LED, Boom Arm, or Power Supply subassemblies.

**CAUTION:** It is recommended to always have the patient wear darkened eyewear during dental procedures. Avoid looking directly into the LED when Lamp is turned on.

**CAUTION:** If the Lens Cover and/or acrylic Fresnel Lens on the Lamp Head needs to be cleaned, use reagent-grade isopropyl alcohol, professional lens cleaning solution, or de-ionized water with a small amount of dish soap - do not use other solvents as they might adversely react with the Lens materials.

# SETTING UP THE UNIT:

**Fig. 1 - System Components**

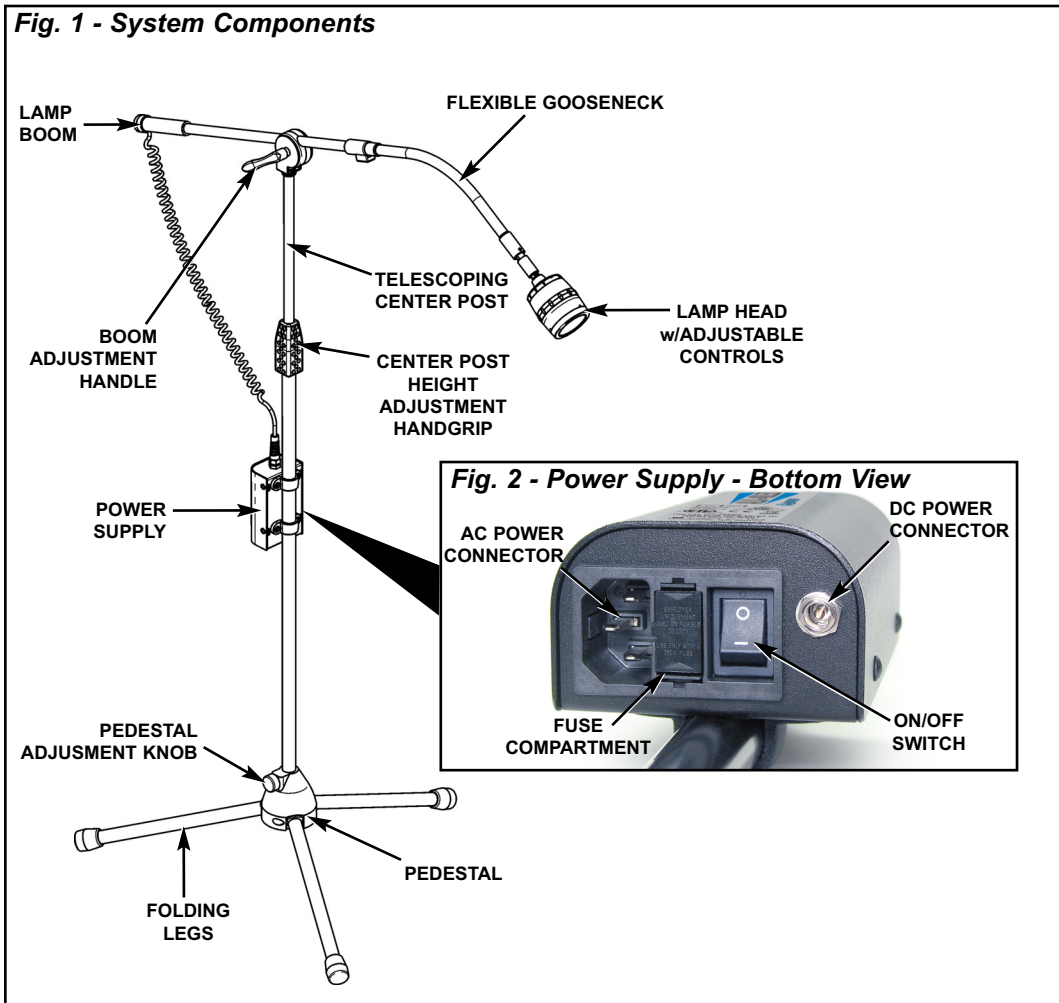

1. Remove the ALU-40LED Lamp from its carrying case. Unfold the tripod legs to a horizontal position. Loosen the pedestal adjustment knob and slide the legs to the bottom of the post (see Figure 1). Secure legs in place by firmly tightening the knob. Set Lamp Assembly on a stable, level floor surface.
2. Loosen the handgrip on the center post (see Figure 1) and raise the post to the desired height. Tighten the handgrip to secure post in place. Loosen the boom adjustment handle and extend boom to desired length and/or pivot the lamp head to the desired operating position. Tighten handle to secure the boom in place.

## SETTING UP THE UNIT - *Cont'd*

3. Attach power cord to receptacle on bottom of power supply housing (see Figure 2, page 3) and plug cord into a grounded electrical outlet. **NOTE:** The ALU-40LED Lamp features auto-sensing, global voltage compatibility for 100VAC, 115VAC, 230VAC, and 240VAC at 50Hz and 60Hz. The fuses provided are correct for these line voltages. **NOTE:** A USA style 110V power cord and 220V adapter are shipped with the unit. Power plug adapters for the specific country of usage may need to be purchased separately.

### **Optional DC Power:**

If the power source is 12VDC or 24VDC, use the optional DC Battery Clip or Adapter Assemblies (see Figure 3) to connect to the DC source. Insert the Assemblies' Power Plugs into the DC Power Jack located on the bottom of the power supply housing (see Figure 2, page 3).

**NOTE:** When attaching the optional DC Battery Clips to the battery, connect the red cable clamp to the positive (+) terminal, and the black clamp to the negative (-) terminal.

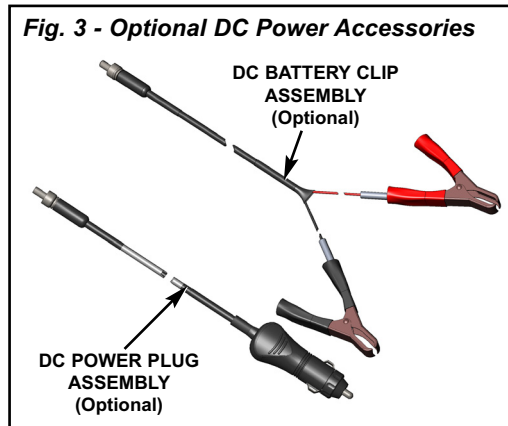

## OPERATION:

After the ALU-40LED Lamp has been set up, the unit is ready to operate:

1. Ensure that the protective Lens Cover is mounted onto the front of the Lamp Head (see Figure 4).

**IMPORTANT:** If applying light-activated composites, it is recommended that the supplied Color Filter, PN: 461974, be used to filter the light from the ALU-40LED Lamp. To install the Filter, remove the Lens Cover and place the Filter against the inside of the Cover (see Figure 5, page 6). Center the Filter so that it completely covers the transparent shield on the Cover. Replace the Lens Cover.

2. Turn On/Off switch located on bottom of power supply housing to On (—) position (see Figure 2, page 3).



### **WARNING:**

Avoid looking directly into LED lamp. Protect patient with darkened eyewear when directing light near patient's eyes.

3. Adjust light intensity and spot size by rotating the two adjustment rings on the Lamp Head (see Figure 4):

#### **a) LED Intensity Adjustment Ring:**

Provides variable brightness control. When viewed from the rear of the Lamp Head, rotate Ring clockwise to increase lamp intensity, or counterclockwise to decrease intensity. The intensity adjustment range is from 0% to 100%. **NOTE:** The total adjustment range of the Intensity Ring covers approximately 90° of rotation -- do not

**Fig. 4 - Illumination Controls**

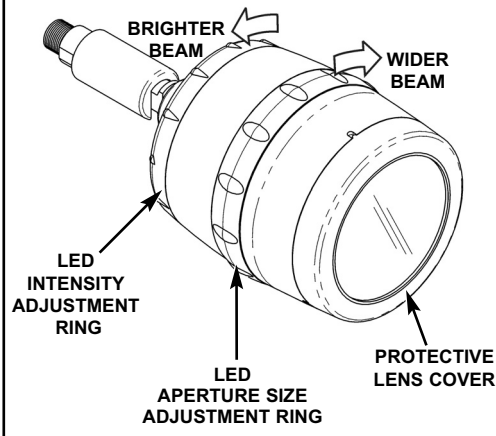

attempt to force the Ring past the stops at each end of this range.

#### **b) LED Aperture Adjustment Ring:**

Allows user to select from seven different beam aperture sizes. When viewed from the rear of the Lamp Head, rotate the Ring counterclockwise to increase beam width, and clockwise to decrease width. **NOTE:** When the Aperture Ring is rotated continuously in one direction, the Lamp will repeatedly cycle through the seven aperture sizes.

# MAINTENANCE

**NOTE:** The Lens Cover, Color Filter, Fresnel lens, Vertical Stand, Fuses, and Power Cords are the only user replaceable parts on the ALU-40LED Lamp. All other Lamp components, such as the LED Assembly, Power Supply, and Boom Assembly are not field serviceable and must be returned to Aseptico if repairs are required.

## 1. FRESNEL LENS REPLACEMENT:

Procure the optional Fresnel Lens Replacement Kit, PN: AA-40LK, from Aseptico. Follow these steps to replace the Lens (see Figure 5):

- a) Turn ALU-40LED power Off and unplug Lamp from power source.
- b) Pull Lens Cover (461936) off the front of Lamp Head to expose the Fresnel Lens (461935).
- c) Use the Torx Key (490140) to remove the three Torx Fasteners (510727). Set Fasteners aside temporarily.
- d) Remove old Fresnel Lens and replace with new Lens, positioning new Lens, rough side out, on the outer shelf on the Front Housing (see Figure 7).

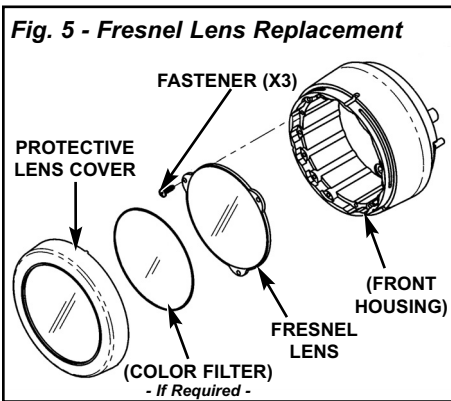

- e) Attach Lens to Housing with the three Fasteners from Step 1c above.
  - f) Replace Lens Cover.
- ## 2. LENS ADJUSTMENT:

Follow these steps to adjust the position of the Lens so that it emits the sharpest beam (refer to Figures 6 & 7):

- a) Position Lamp Head approximately 28" (71 cm) away from a flat test surface. Turn Lamp On and observe sharpness of projected light beam (see Figure 5).

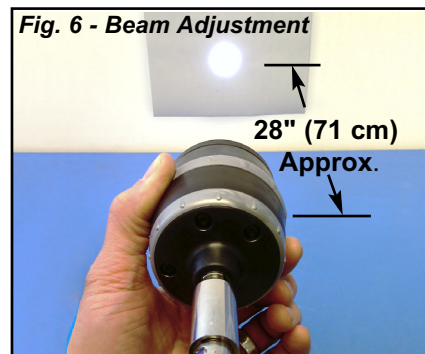

- b) If outer edge of beam appears blurred or undefined, reposition the Lens on the next inboard shelf (see Figure 7) of the Housing (refer to Step 1 for complete instructions when detaching and reattaching the Fresnel Lens).
- c) Repeat Step 2b, moving the Lens inward to the next shelf until the edge of the beam shows optimum sharpness and clarity. **NOTE:** There are a total of five different Lens adjustment shelves in the Front Housing (see Figure 7).



**Fig. 7 - Lens Adjustment Shelves**

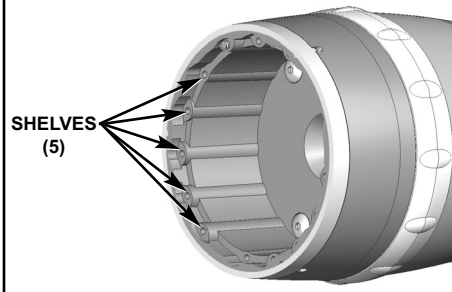

**IMPORTANT**

The LED Assembly is a non-serviceable component of the ALU-40LED Lamp. Return the entire Lamp Assembly to Aseptico if LED repairs are necessary.

**3. FUSE REPLACEMENT:**



**WARNING**



Turn the power off and unplug the unit before following the steps below.

- a) Remove the Fuse Holder from the Power Inlet connector (see Figure 8).

**Fig. 8 - Changing Fuses**

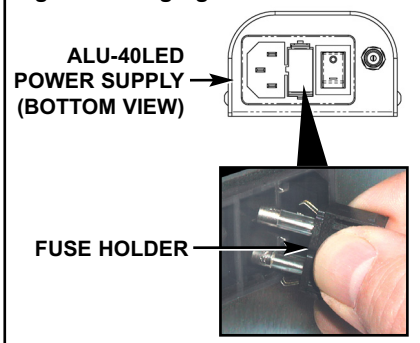

- b) Replace the two fuses in Fuse holder.

**Replacement Fuses (2):**

0.160A, 250V slo-blow fuse  
(Fuse size: 5 x 20mm)

- c) Reinstall the Fuse Holder.  
**NOTE:** The ALU-40LED features auto-sensing, global voltage compatibility. The fuses indicated are correct for 100V-240V 50/60 Hz line voltages.

**4. CLEANING:**



**WARNING:**

Turn the power off and unplug the unit before following the steps below.

**CAUTION:**

- Do not use excessive amounts of fluid when cleaning.
- Do not introduce any fluids to the inside of the Lamp Head Housing or the Power Supply Assembly.

- a) **Fresnel Lens:**

Remove Lens Cover and Fresnel Lens from Lamp Head. (**IMPORTANT:** Handle the Fresnel Lens by its edges -- do not handle the active surface of the Lens.) The acrylic Fresnel lens is fragile and can be scratched. Dust is the most common contaminant and should be removed using compressed air. If additional cleaning is necessary, apply a few drops of reagent-grade isopropyl alcohol, professional lens cleaning solution, or de-ionized water with a small amount of dish soap, to a lint-free lens tissue and gently wipe Lens. Clean the Lens Cover using the same method. Reinstall Fresnel Lens and Lens Cover onto Lamp Head.

- b) **Metal Components:**

The metal exterior may be cleaned by wiping with a soft cloth moistened with mild detergent or disinfecting solution such as isopropal alcohol.

- c) **Gooseneck & Electrical Cords:**

Turn Lamp power Off. Wipe down the gooseneck and electrical cords with a cloth moistened with disinfecting solution.

# ALU-40LED PARTS DIAGRAM

Figure 9 - Lamp Stand Boom

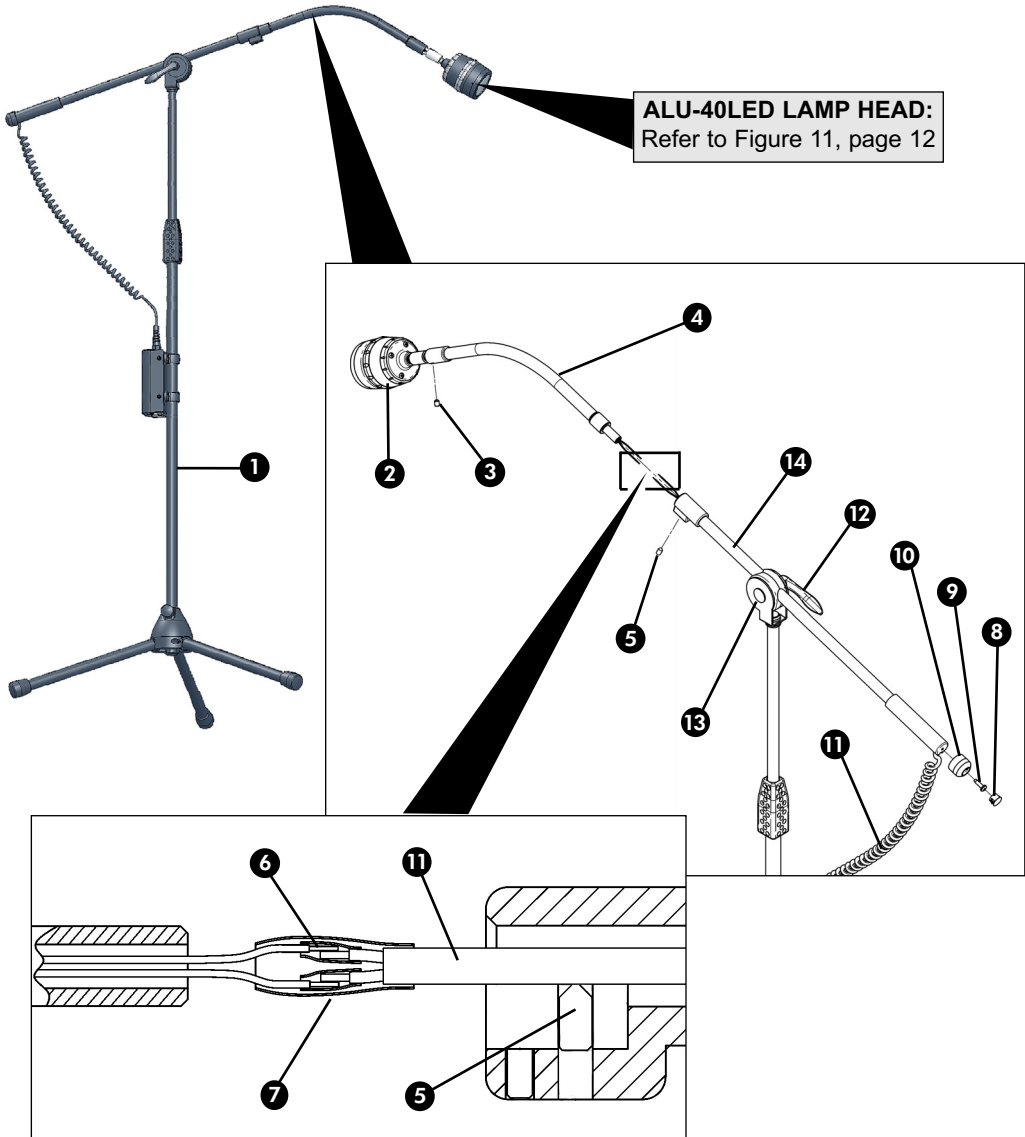

## PARTS LIST - Lamp Stand Boom

Item	Description	Part Number	Qty
①	FINAL ASSY, ALU-40LED	120369	1
②	LAMP HEAD SUB ASSY	330355	1
③	SETSCREW 8-32X1/8 S/S CUP POINT	510278	1
④	GOOSENECK ALU-40LED DENTAL LAMP	461953	1
⑤	SET SCREW CONE PT HEX SOC M6 X 8MM BLK	510731	1
⑥	HEAT SHRINK 1/8 BLK	870118	1"
⑦	HEAT SHRINK 1/4 BLK	870120	2.5"
⑧	HOLE PLUG NYLON 1/2 IN BLACK	510202	1
⑨	M/S STNLS PHDPHL 10-24 X 5/8 THRD CUTTING	510732	1
⑩	END CAP, MODIFIED BOOM, ALU-40	461959	1
⑪	CABLE COILED 2 CONDUCTOR ALU-40LED	870319	1
⑫	HANDLE CLAMP LEVR, M8X1.0 FEM THRD, BLK	850076	1
⑬	CLAMP, BOOM ALU-40 LED	730646	1
⑭	BOOM, MODIFIED ALU-40LED	730645-01	1

*Cont'd on page 11...*

# ALU-40LED PARTS DIAGRAM

Figure 10 - Lamp Stand & Power Supply

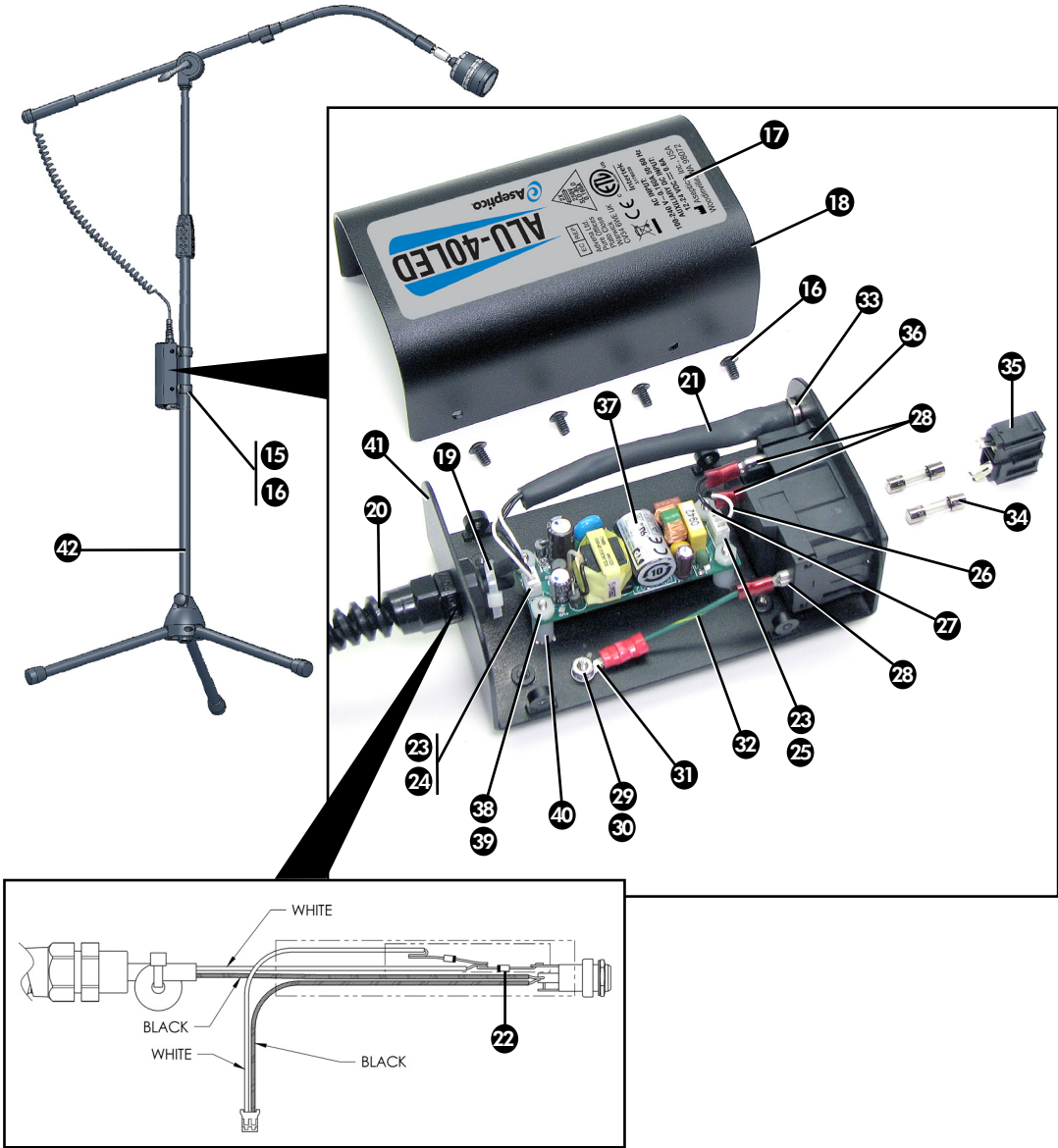

## PARTS LIST - Lamp Stand & Power Supply

Item	Description	Part Number	Qty
15	BRACKET POLE POWER SUPPLY ALU-40LED	461945	2
16	C/S BTNSOC BLK 6-32 X 1/4	510009	8
17	OVERLAY POWER SUPPLY ALU-40LED	420910	1
18	TOP HOUSING POWER SUPPLY ALU-40LED	461943	1
19	TIE WRAP 4" PICO WHT	510137	1
20	STRAIN RELIEF 1/4 BLK FLEX	840003	1
21	HEAT SHRINK 1/2 BLK	870121	0.29'
22	DIODE GENERAL 1N4004 1A 400V AXIAL DO-41	880030	2
23	CONN CRIMP CONTACT 30-24 AWG	860266	4
24	CONN .079 HSG/POL 2 PIN	860267	1
25	CONN .079 HSG/POL 3 PIN	860268	1
26	WIRE PVC #24 STRANDED WHITE	870304-01	0.46'
27	WIRE PVC #24 STRANDED BLACK	870304-02	0.54'
28	TERM FEM CONN .187 X .032 22-16	860053	3
29	NUT HEX 6-32 STNLS (FOR GRND STUD)	510293	1
30	WASHER, INT STAR #6 (FOR GRND STUD)	510419	1
31	TERM INSUL RING #6 22-16	860004	1
32	WIRE PVC #22 GRN/YEL (54)	870260	0.21'
33	CONN JACK DC POWER PANEL MOUNT	860258	1
34	FUSE 5 X 20 SLO-BLO 0.160 AMP	830046	2
35	FUSE DRAWER 2 POLE	840060	1
36	POWER INLET, FUSED SWITCHED	840059	1
37	POWER SUPPLY 12VDC 0.83A INPUT 85-264 VAC	840112	1
38	NUT NYLON 4-40	510554	4
39	WASHER FLAT NYLON .120IDX.250 ODX.0	510127	4
40	SPACER NYLON 1/4 RND X 7/16 L #6	510267	4
41	BASE POWER SUPPLY ALU-40LED	461944	1
42	STAND ALU 27/29 AKG BLK	730150	1
NS	COLOR FILTER ALU-40LED	461974	1
NS	CASE CARRYING W/BLU LOGO	410084	1
NS	ADAPTER AMERICAN-TO-GERMAN GRND PLUG	840115	1
NS	LINECORD REMOTE US BLACK	840107	1
NS	LABEL SERIAL NUMBER ALU-40LED	420295-09	1

(\*NS = NOT SHOWN)

Figure 11 - Lamp Head

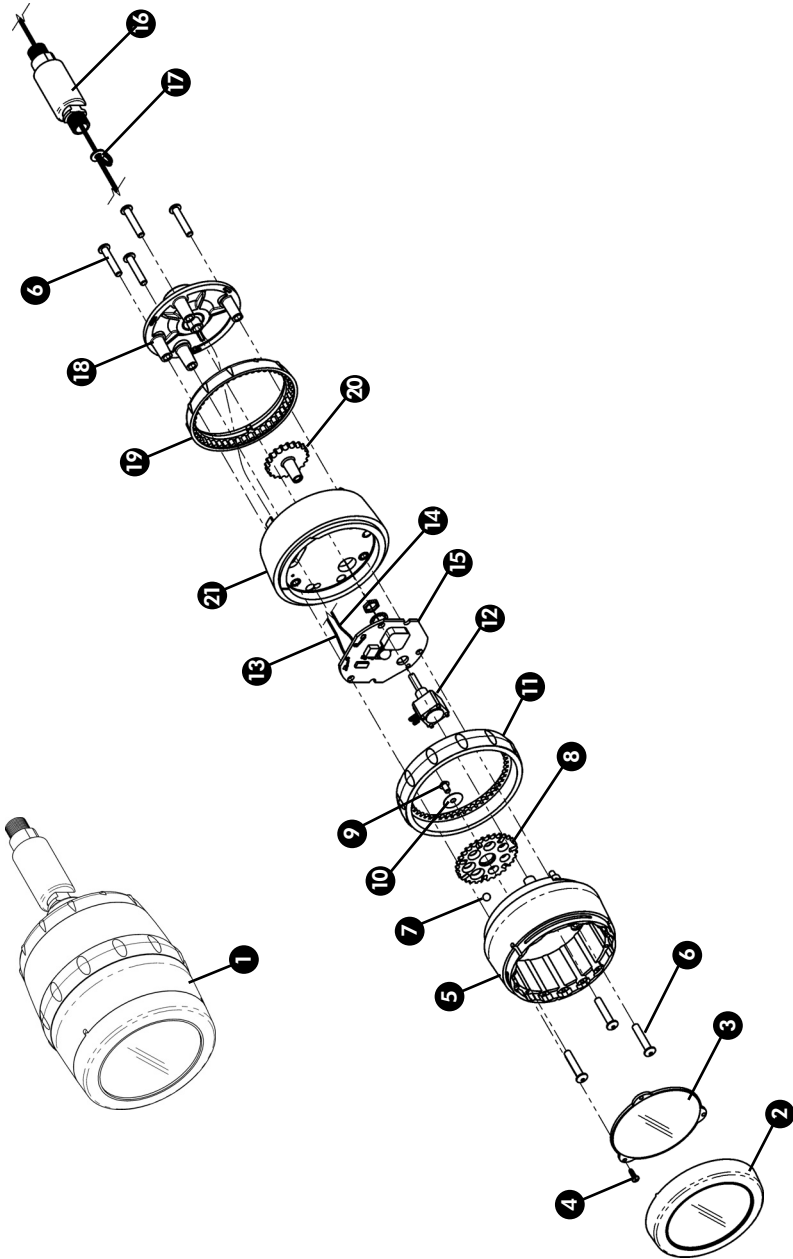

## PARTS LIST - Lamp Head

Item	Description	Part Number	Qty
①	LAMP HEAD SUBASSEMBLY ALU-40LED	330355	1
②	LENS COVER ALU-40LED	461936	1
③	LENS FRESNEL ALU-40LED	461935	1
④	M/S M2-4 X 6 SIX LOBE THREAD FORMING	510727	3
⑤	FRONT HOUSING ALU-40LED	461934	1
⑥	C/S BTNSOC BLK 6-32X3/4	510034	7
⑦	BALL STAINLESS 0.156 DIA	510738	1
⑧	APERTURE WHEEL ALU-40LED	461932	1
⑨	C/S BTNSOC BLK 4-40X3/16	510488	1
⑩	WASHER SHIM .43 OD X .115 ID X .01 STNLS	510726	1
⑪	APERTURE ADJUST RING ALU-40LED	461931	1
⑫	RES 100K TRIM POT 350V 1/2W	810430	1
⑬	WIRE #24 TEFLON 41/40 TINNED COPPER WHT	870314	2'
⑭	WIRE #24 TEFLON 41/40 TINNED COPPER BLK	870320	2'
⑮	PCB ASSY LAMP HEAD ALU-40LED	330578	1
⑯	FTN UNIVERSAL JOINT M10-1.0 MALE THRDS	730643	1
⑰	WASHER #6 NYL .140 ID X .312 OD X .032 THK	510573	1
⑱	REAR HOUSING PLATE ALU-40LED	461937	1
⑲	BRIGHTNESS ADJUSTMENT RING ALU-40LED	461941	1
⑳	BRIGHTNESS ADJUSTMENT GEAR ALU-40LED	461947	1
㉑	REAR HOUSING ALU-40LED	461933	1

## TROUBLESHOOTING:

<b>Problem:</b>	<b>Correction:</b>
Power is 'ON', but lamp does not illuminate:	<ul style="list-style-type: none"><li>- Turn intensity up.</li><li>- Replace fuses, 0.160 Amp, 5 x 20mm, 250V, slo-blow</li><li>- Check plug and electrical source.</li></ul>
Light intensity appears dimmer than normal:	<ul style="list-style-type: none"><li>- Turn intensity up.</li><li>- Clean Lens Cover and/or Fresnel Lens. (Note: Before cleaning, turn power to Lamp 'Off'.)</li><li>- Check plug and electrical source.</li><li>- LED Assembly might be damaged - Return entire Lamp Assembly to Aseptico for repairs.</li></ul>
Fuse is blown:	<ul style="list-style-type: none"><li>- Replace both fuses, 0.160 Amp, 5 x 20mm, 250V, slo-blow</li></ul>



# SPECIFICATIONS:

Lamp Height: 41" to 69" (Adjustable)  
 (104.1 cm to 175.3 cm)

Boom Length: 41" (104.1 cm)

Weight: 9.45 lbs (4.29 kg)

AC Input: 100-240V ~ 0.160A  
 50-60 Hz

Auxiliary DC Input: 12-24V = 0.6A

Fuses: 0.160 Amp, 250V, slo-blow  
 (5 x 20 mm)

Consumption: 7.5 W max

Duty Cycle: Continuous

LED Life: 10,000 Hrs minimum  
 (Lumen maintenance >70%  
 @ 30,000 Hrs - At worst  
 case operating temperature)

### Lamphead Adjustments:

Intensity: 0% to 100% Adjustable

Aperture Size: 2-1/4" to 4-5/8" Diameter  
 (5.72 cm to 11.74 cm)  
 Adjustable @ 27.56 in.  
 (70 cm) focal length

### Beam Characteristics:

Color temperature: 6,500 Kelvin

Light Output: 1,500 ft-c @ 24" Typ  
 (16,145 lux @ 61 cm Typ)

Light Distribution: 7 different aperture sizes

Nominal Working Distances:  
 16" (40.6 cm) w/large  
 aperture, or 36" (91.4 cm)  
 w/small aperture

Light Source: LED Emitter

### Environmental Conditions:







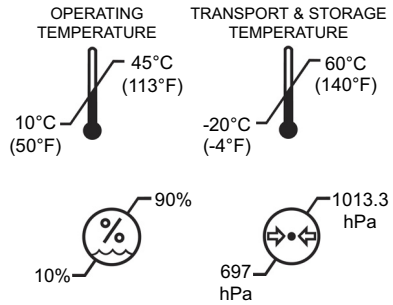





Operating Temperature: 10 to 45°C (50 to 113°F)  
 Transportation & Storage Temperature: -20 to 60°C  
 (-4 to 140°F)

Relative Humidity: 10 to 90% non-condensing

Altitude: 0 to 3,048 meters (0 to 10,000 ft.)



## SYMBOL DEFINITIONS:

	Attention, consult accompanying documents		Protective Earth (Ground)
	Type B Equipment		Temperature Limitation
	Class II Equipment		Humidity Limitation
	Dangerous Voltage		Atmospheric Pressure Limitation
	Alternating current		Do Not Throw Into Trash
	Manufacturer		Fuse Rating
	Authorized European Representative		

## **WARRANTY**

Aseptico warrants this product against defects in material or workmanship for a period of two (2) years, from date of original invoice. Some handpieces are warranted for one year under the same conditions. Other handpieces and expendable components, such as air turbines and light bulbs, are covered by shorter warranty periods, or have no warranty. Aseptico's sole obligation under product warranty is (at its sole option and discretion) to repair or replace any defective component or product in part or whole. Aseptico shall be the sole arbiter of such action.

In the event of alleged defect under warranty, the purchaser is to notify Aseptico's Customer Service Department promptly. Customer Service will provide instructions, usually directing that the product be returned for service. Shipment to Aseptico and the cost thereof is always the responsibility of the purchaser.

Accidental misuse, inappropriate installation, or failure to perform directed maintenance voids the warranty. Deliberately defacing, modifying, or removing the serial number voids the warranty.

Aseptico does not assume, under this warranty, any risks or liabilities arising from the clinical use of its products, whether or not such use involves coincidental utilization of products manufactured by others.



P.O. Box 1548 • Woodinville, WA 98072  
8333 216<sup>th</sup> Street S.E. • Woodinville, WA 98072  
(425) 487-3157 • (800) 426-5913  
[www.aseptico.com](http://www.aseptico.com) • [info@aseptico.com](mailto:info@aseptico.com)

P/N: 420841  
Rev. F  
ECO 13305  
03/2014

PRINTED IN THE USA